



KAM YEUNG COMPANY LIMITED







Solar Brand Remote Control: Open & Close Curtain Track, Electromagnetic Clutch,
Guaranteed DIY Installation,
Roller Blind, Vertical Blind, Venetian Blind & Skylight Shade

<P. 1>

Electronic Remote Control Roller Blind (Normal Type)

Operation Instructions:

Default limited positions of the blind were presetted by factory. You may reset these positions in the following steps.

- (1)  is a button of moving down and stop.
- (2)  is a button of moving up and stop.
- (3) The setting of downward limited and upward limited positions are as follows:
 - (a) You **MUST** set the downward limited position first.
 - (b) Press the **SET** button for **6 seconds** till the **red** light flash and release the button.
 - (c) Press the  button, the blind will go down till to the desired downward limited position and press the same button again to stop the blind.
 - (d) Press the **CONFIRM** button to confirm the downward limited position.
 - (e) Press the  button, the blind will go up till to the desired upward limited position and press the same button again to stop the blind.
 - (f) Press the **CONFIRM** button to confirm the upward limited position. The **red** light will change to **green** light and stop to flush. The setting is completed now.
- (4) You can press the  or  button, the blind will go down or up to your desire position within you presetted downward and upward limited position.
- (5) Small buttons of **R●** & **S●** are changed the current. The meaning is changed the rolling direction of the blind.
- (6) Use a small stick to press the button **R●** for few seconds till to **red** light flash and then press button **S●** till to the **red** light changed to **green** light. This setting is complete.

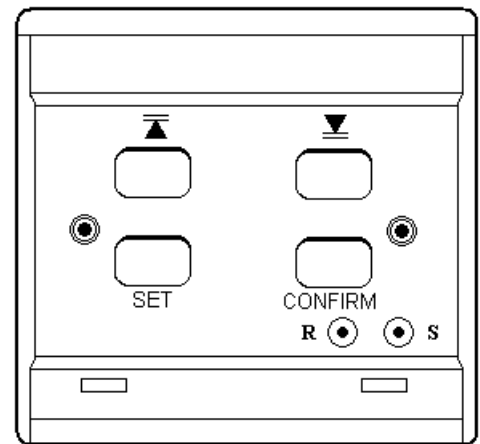

Remarks: Distances of 100mm beyond the limited positions are sensitive. Please avoid stopping the blind within these areas. Occasionally this changes the preset limits as a result of doing so.



SOLAR Brand

KAM YEUNG COMPANY LIMITED

Solar Brand Remote Control: Open & Close Curtain Track, Electromagnetic Clutch, Guaranteed DIY Installation, Roller Blind, Vertical Blind, Venetian Blind & Skylight Shade

<P. 2>

Electronic Remote Control Roller Blind (New Version)

Special Functions

- Single blind control, group blinds control.
- Code can be changed.
- Auto stop when blind was obstructed.
- Additional socket for external control. (Home Automation)

Operation Instructions:

- (1) Setting of downward and upward limited position, please refer the normal type.
- (2) Single blind control: as the normal type.
- (3) Group blind control: please refer the attached drawing 1 and photos 1, 2, 3 & 4.
- (4) Group remote controller (refer figure i). Press the **SET** button then release. The light will shift from 1 to 2 to 3 to 4 to 5 to 1.
- (5) Input a code to the wall mount control board (refer **figure ii**). Press the confirm button for 3 second till the **red** light flush and release the button. Point the remote controller toward the wall mount control board and press the left top button of remote controller. You will hear a sound of **Di**. The **red** light will change to **green** light and stop to flush. The setting is completed. If you have a group remote controller, you may follow item 4 to input a code to group control wall mount board.

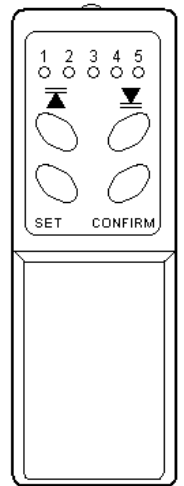

<figure i>

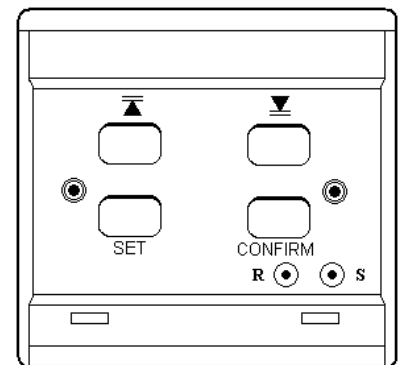

<figure ii>

- (6) Setting for Motor Power: Use a small stick to press the button **S** of wall mount control board for 3 seconds till the **red** light flush and then press button **R** to increase power and press button **S** to decrease power. 50 times to maximum you will hear a sound **Di-Di-Di** and 50 times to minimum you will also hear a sound of **Di-Di-Di**. Press button **SET** to confirm the power setting.



KAM YEUNG COMPANY LIMITED

Solar Brand Remote Control: Open & Close Curtain Track, Electromagnetic Clutch, Guaranteed DIY Installation, Roller Blind, Vertical Blind, Venetian Blind & Skylight Shade

SOLAR Brand

<P. 3>

Electronic Remote Control Roller Blind (New Version)

(7) Additional five pin socket (refer photo & drawing): You may connect this roller blind system to your control centre (Home Automation). Insert your plug to the socket (as the drawing), you can control this roller blind by your control centre (Home Automation).

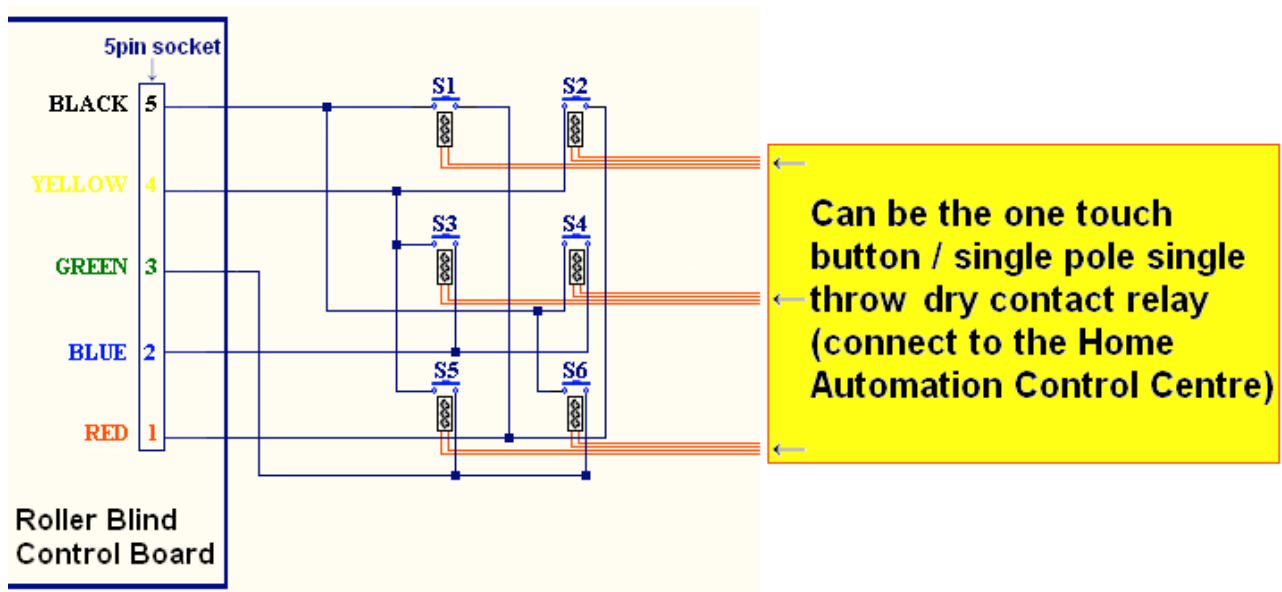

BLACK 5	touches	RED 1	=	UP & STOP	(S1)
YELLOW 4	touches	RED 1	=	DOWN & STOP	(S2)
YELLOW 4	touches	BLUE 2	=	SET	(S3)
BLACK 5	touches	BLUE 2	=	CONFIRM	(S4)
YELLOW 4	touches	GREEN 3	=	R & +	(S5)
BLACK 5	touches	GREEN 3	=	S & -	(S6)

Play Attention on Group Control

Single Blind Control:

You should connect the individual roller blind and complete the setting.

Group Blind Control:

You should turn off the power supply of individual roller blind, and then connect the group control lines as the photos or drawing. Finally, turn on the power supply of all individual roller blinds.

Now, you can control all individual roller blinds by a group control wall mount board. (refer photo).



KAM YEUNG COMPANY LIMITED

Solar Brand Remote Control: Open & Close Curtain Track, Electromagnetic Clutch, Guaranteed DIY Installation, Roller Blind, Vertical Blind, Venetian Blind & Skylight Shade

SOLAR Brand

<P. 4>

Electronic Remote Control Roller Blind (New Version)

<Drawing 1>

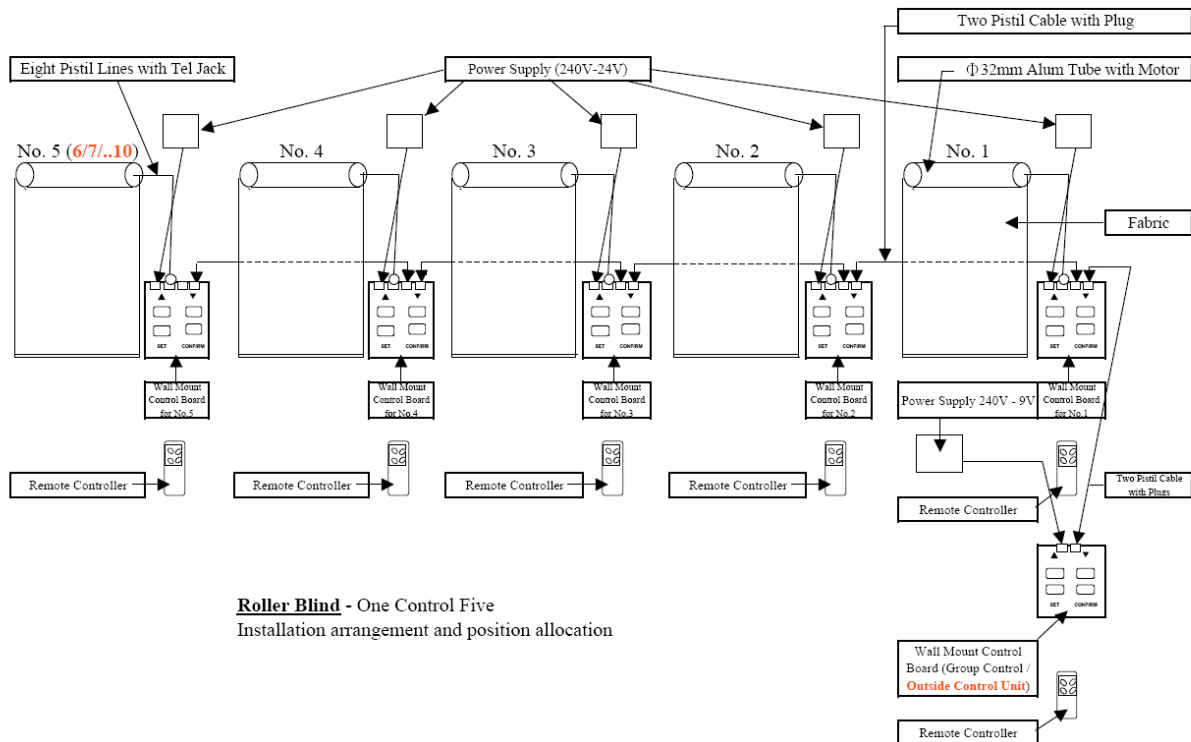

Caution : Once you need to connect the power to the motor, please plug the 8 pin cable to 8 pin socket first and then the power pin to the power socket. The action should be gentle and keep the movement in level. On the other hand, if you want to disconnect the power, please unplug the power pin first and then the 8 pin cable. It is because the 8 pin plug and socket are rather delicate. It is easy to cause a short circuit. If the power is there, the transistor may burn out.



KAM YEUNG COMPANY LIMITED

Solar Brand Remote Control: Open & Close Curtain Track, Electromagnetic Clutch, Guaranteed DIY Installation, Roller Blind, Vertical Blind, Venetian Blind & Skylight Shade

<P. 5>

Electronic Remote Control Roller Blind (New Version)

Photo 1: Single Control Wall Mount Board
Front View



Photo 2: Single Control Wall Mount Board
Side View



Photo 3: Group Control Wall Mount Board
Front View



Photo 4: Group Control Wall Mount Board
Side View

